



# XTD-010-4050 -linear light

Flat cover



Arc cover



# Datasheet





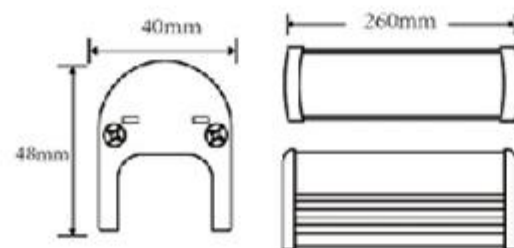
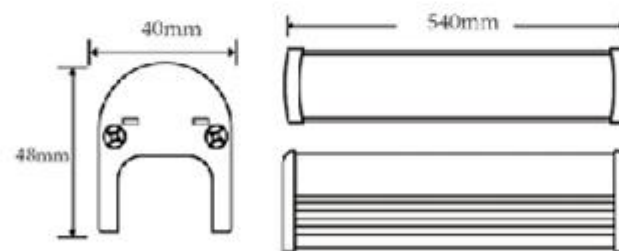
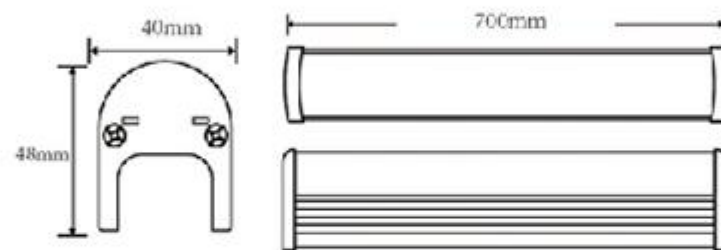
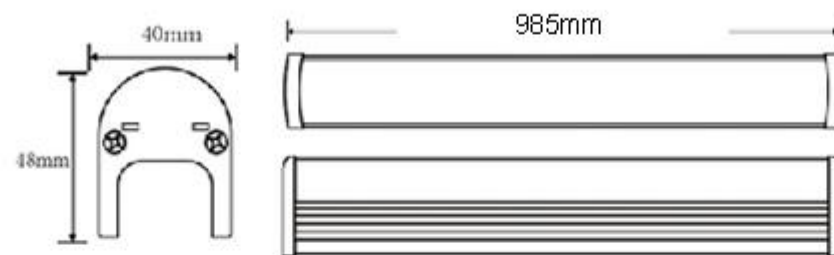

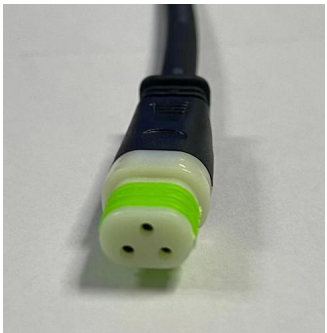

<b>Item No.</b>	<b>JX-XTD-010/4050-Linear light</b>				
<b>Voltage(V)</b>	DC24V				
<b>Wattage(W)</b>	<12W				
<b>Type of light Source</b>	SMD5050 Sanan/Epistar				
<b>Luminous color</b>	W/WW/Y	R/G/B	RGB-TTL	DMXRGB	DMXRGBW
<b>Pixel Number/M</b>	/	/	8	8	8
<b>IC number</b>	/	/	1912IC	512C0+1912	512C0+1912
<b>Control</b>	/	/	TTL/DMX512	DMX512	DMX512
<b>Channel</b>	/	/	3	3	4
<b>Number of leds</b>	48Leds	48Leds	48Leds	48Leds	48Leds
<b>Chip Package</b>	SMD5050	SMD5050	SMD5050	SMD5050	SMD5050
<b>Ra</b>	>79				
<b>LM</b>	120LM/W				
<b>Beam Angle</b>	120Degree				
<b>Materials</b>	Aluminum Profile+PC Cover				
<b>Light body color</b>	Light grey				
<b>Working Temperature</b>	—22℃~+58℃				
<b>Lamp Life</b>	>30000Hours				
<b>Adjustable Angle</b>	No				
<b>Regular Size</b>	L985*H48*W40MM				
<b>Warranty</b>	2Years				

# Available size



# Accessories

## Full color(RGB)

Full color(RGB)				
				
Clip	3pin Connector	T Connector(10 light/pcs)	DC24V power Supply	Led Controller
Single color				
				
Clip	Female Connector	Male connector	DC24V power Supply	

# Single color Wiring

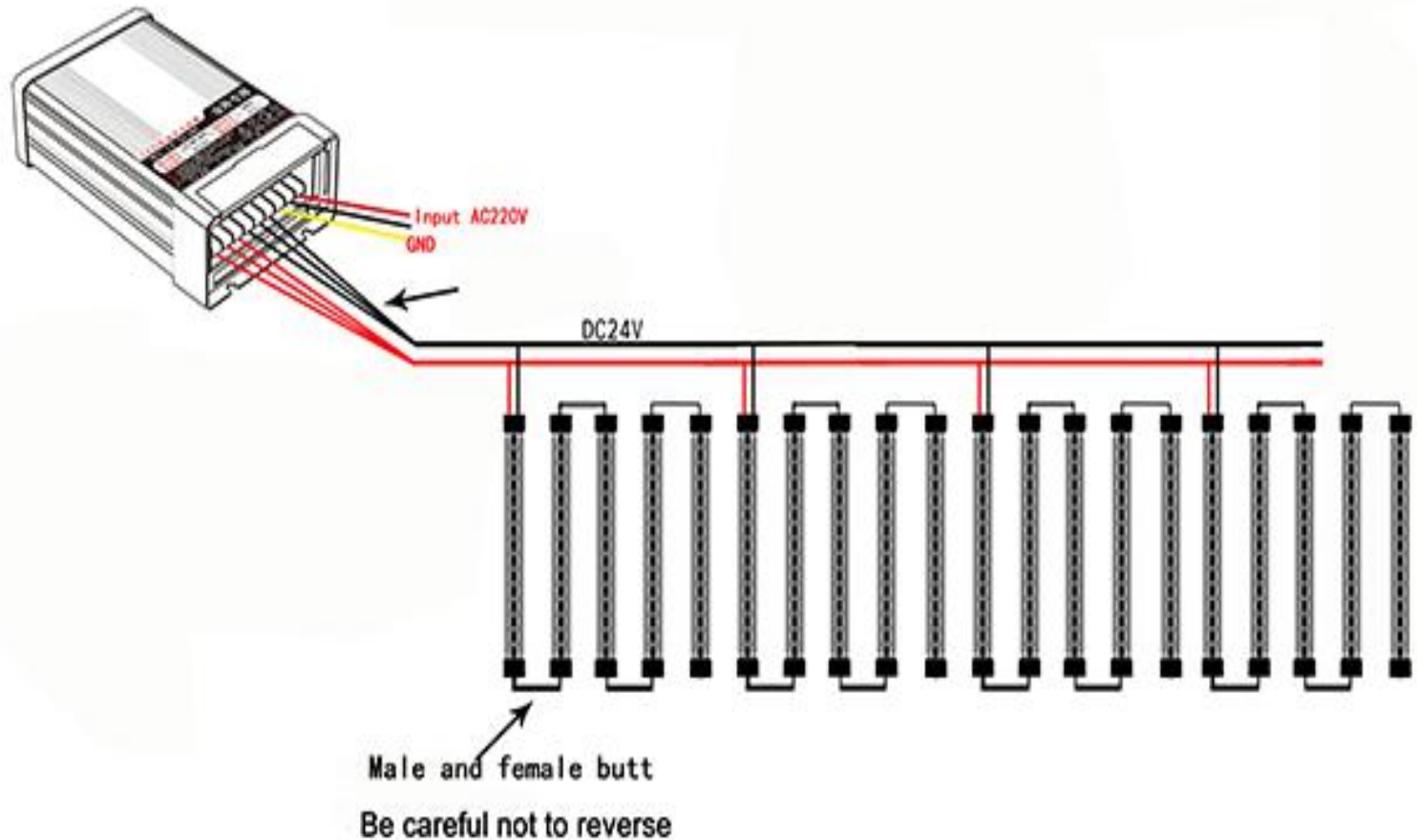

# Full color(TTL)Wiring

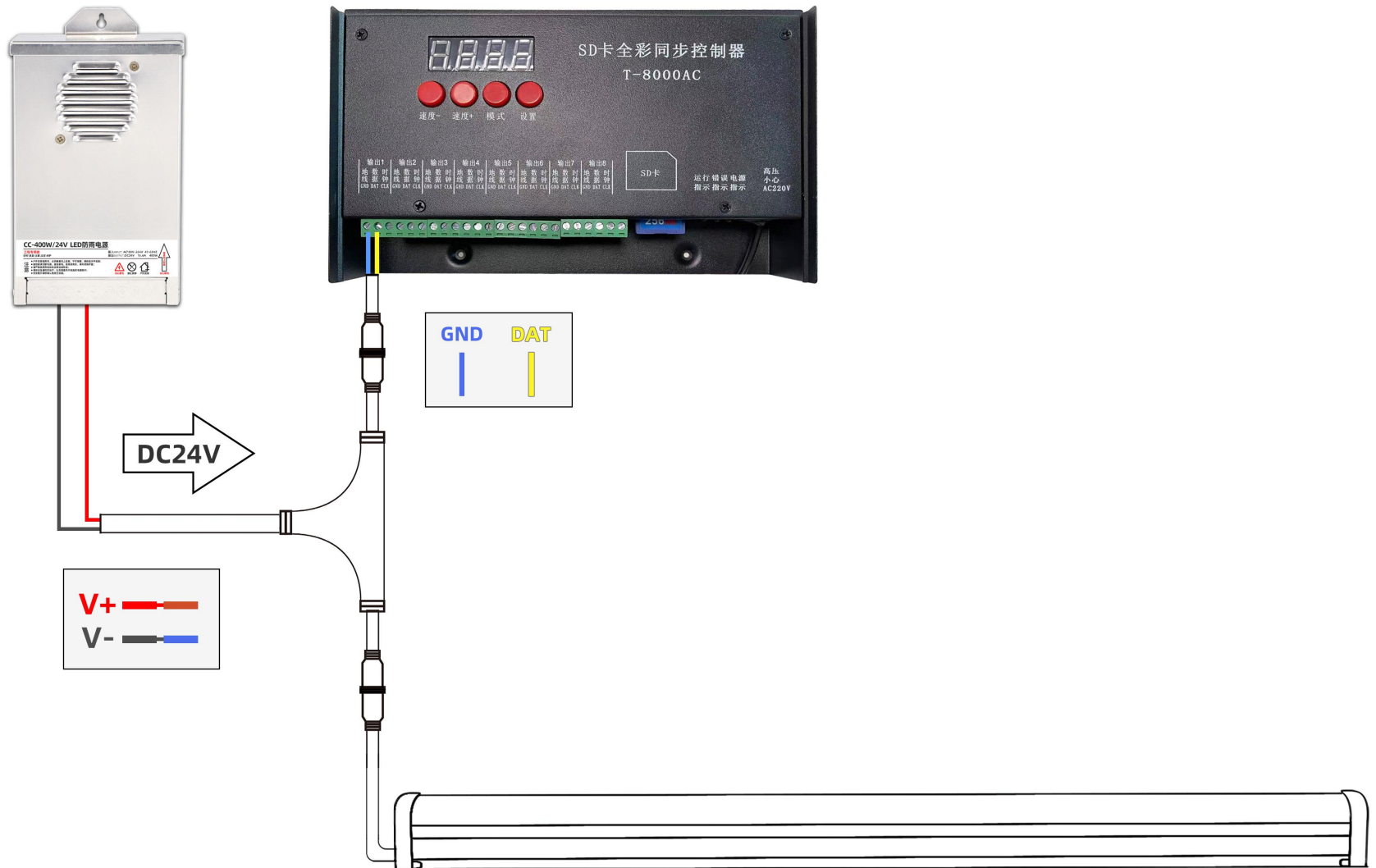

# DMX512rgb Wiring

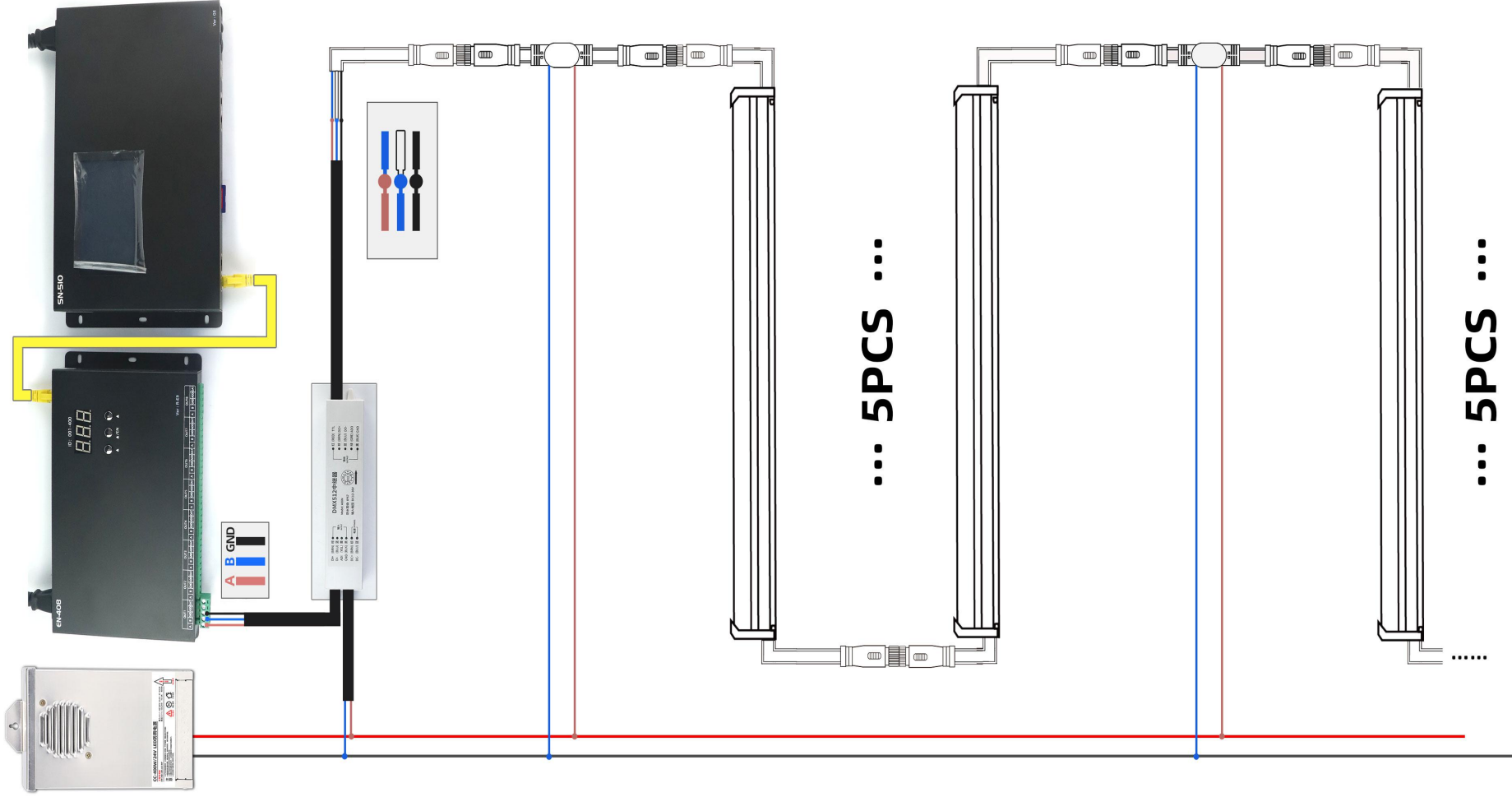

# Installation method

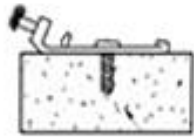

1. First nail the buckle into the wall

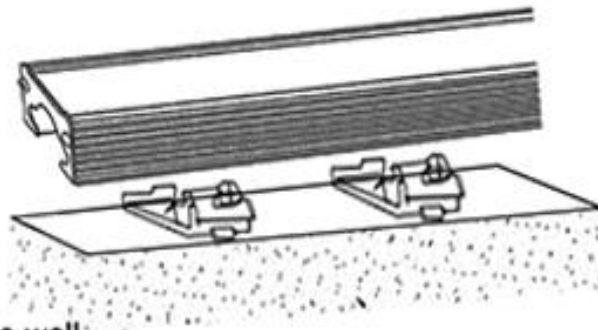

2. Install the lamp into the buckle

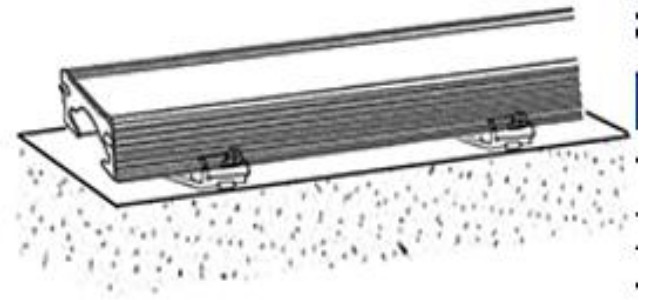

3. Tighten the buckle with screws



# Packing Details

N.G(kgs)/pcs	QTY'S/CTN	G.W(kgs)/CNT	Carton size	CMB/CTN
0.5kgs/pcs	30PCS	12.8KGS	105*25.5*23	0.062CMB



# Customized

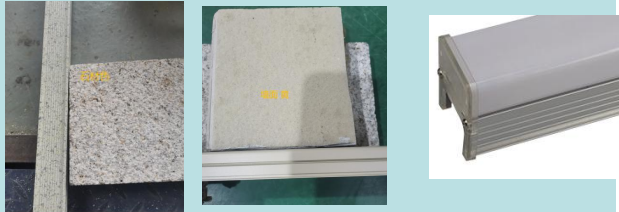

**Body color can customized the color according to the building color(please confirm with sales represent)**



**PC cover Sharp can choose Arc or flat Sharp**

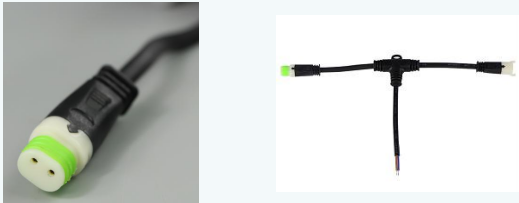

**Size of the Connector and color of the Connector can customized**

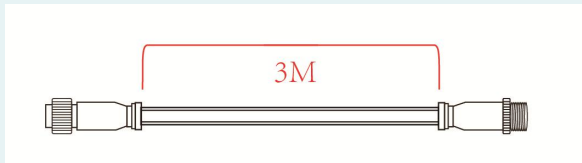

**Signal extension cable size can be customized to any size(less than 80M) according to the project**

# Application



Building Outline-Yellow



Building outline-rgb



Building screen-rgb



Advertising signs



Bridge



River course



## CONTACT US

### **Address 1:**

Street 60m , opposite of German Village, As Sulaymaniyah, Iraq.  
+(964) 750 155 2912

### **Address 2:**

Zargata, Opposite Girls Union High School, As Sulaymaniyah, Iraq.  
+(964) 770 350 9001

### **Address 3:**

Bakhtiari, Opposite Spaceton, Erbil, Iraq.  
+(964) 750 888 3031 | +(964) 750 999 3031

www.akamlighting.com  
info@akamlighting.com

ژماره مۆبایلی ئاکام:  
+(964) 770 155 2912

## په یوهندی

### **لقى یه کم:**

سلیمانی - شهقامی بازهی مهلیک مهحمود - بهرامبهه گوندی نهلمانی  
+(964) 750 155 2912

### **لقى دووهم:**

سلیمانی - زههگهته - بهرامبهه نامادهیی بهکیتهی کچان  
+(964) 770 350 9001

### **لقى سییهه:**

ههولیه - دوو ساپدی بهختیاری - بهرامبهه سپهپستوون  
+(964) 750 888 3031 | +(964) 750 999 3031

www.akamlighting.com  
info@akamlighting.com